

Article number: 2310431039

Description: E+G Levelling elements  
LX.40-SW17-M8X70

## Measures

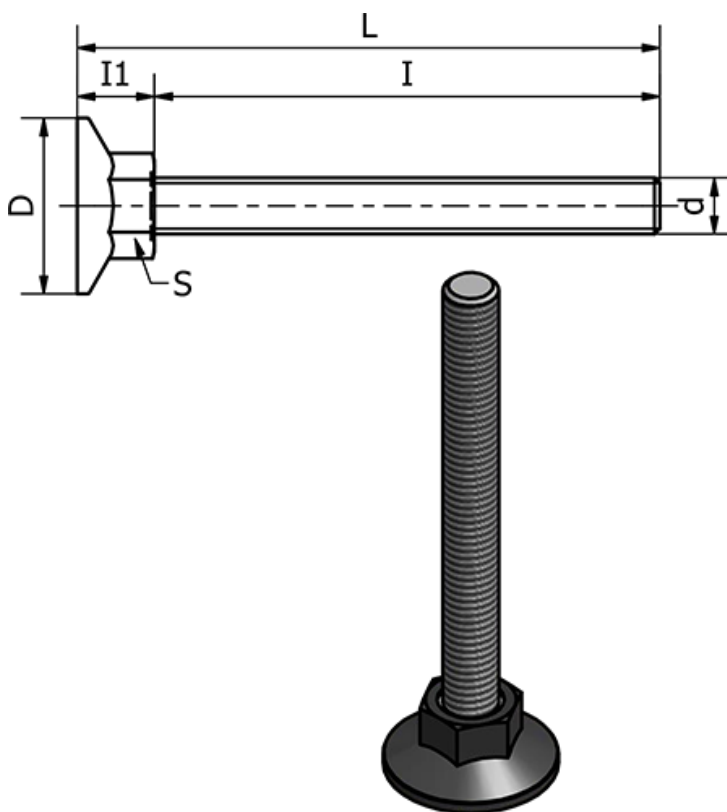

d	= M8
D	= 40
I	= 70
I1	= 13
L	= 82.5
S	= 17
Static load in (N)	= 2500
Type	= Forzinket

Weight (g) = -